

PINK PROVIDES:

- 1 13' Arch Fabric
- 1 Set of 13' Arch Metals
- Extra Pop Buttons

YOU PROVIDE:

- Small Tool Kit
- Site Plan/Event Layout
- Three Person Team Min.
- Plastic Drop Cloth
- Shears or Diagonal Cutters
- Gloves
- Sewing Kit
- Zip-Ties
- Allen Key Set



Additional Support Please Call:
212-253-6666 or
After Hours: 646-853-3900

Metals are labeled for easy assembly. Simply match the corresponding parts, depress the button, and slide together.

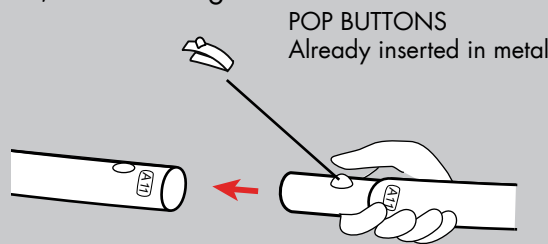

Prior to assembly, lay out drop cloth in designated work location. Before working with fabric, wash hands or put on gloves.

1. Join pieces to create the two arch forms and the two bases.

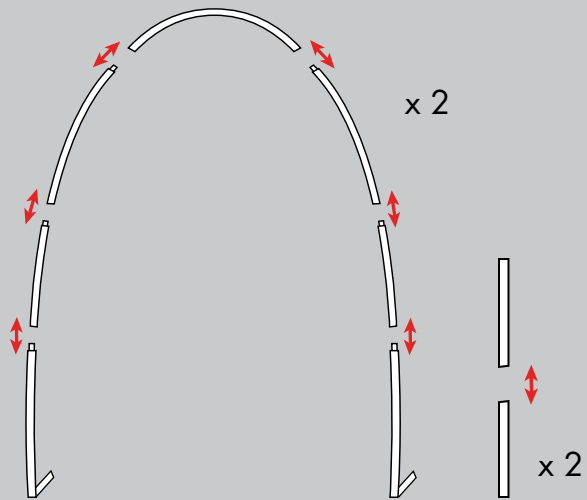

2. Lay one of the arches on its side. Attach the two base supports.

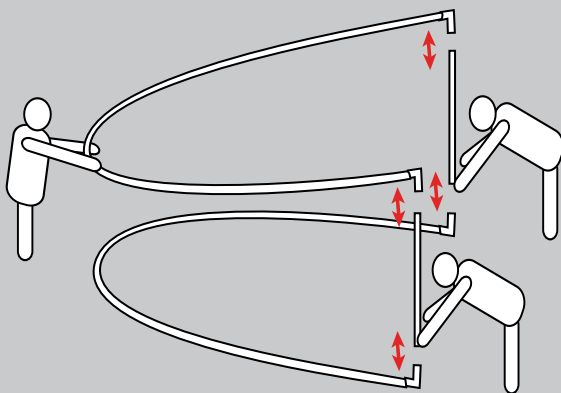

It is easiest to have one person hold the "top" arch approximately 12" from the ground.

3. Use an allen key to screw the top piece into place.

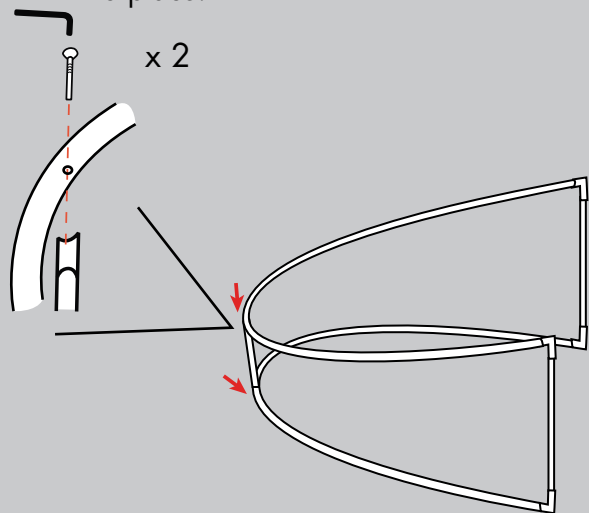

Any and all rights (including, without limitation, copyright, design patent, use patent and trademark) in and to all designs, concepts, renderings, or graphics (collectively, "Design") represented in this document were created by Moss Inc. and remain the sole and exclusive property of Moss Inc. Use of any such Design by the recipient without required purchase is strictly prohibited. ©2010

4. Lay out the fabric and place it onto the frame on top of the drop cloth.

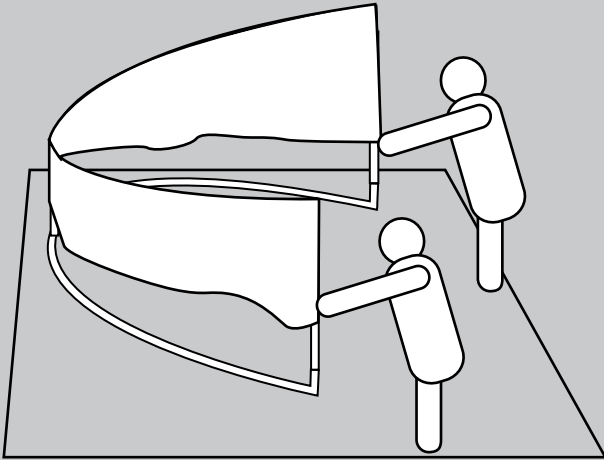

5. Stretch the fabric over the entire frame; find the zipper at the bottom.

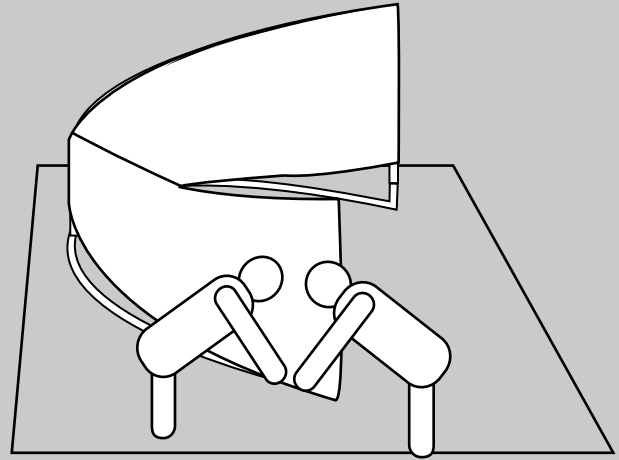

6. Have one person pull the fabric over the metal while another one zips. The fabric is strong, so we encourage pulling hard!

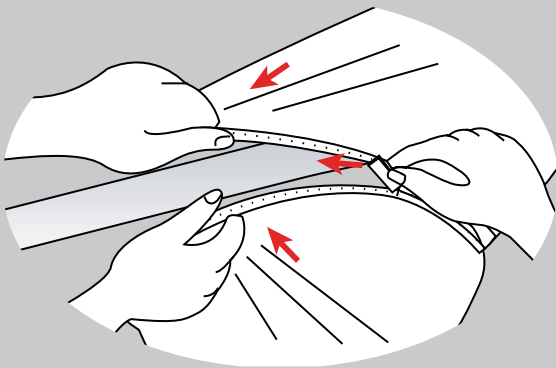

7. Stand the Arch and place in the desired location.

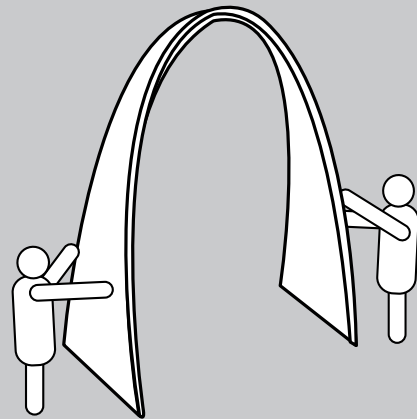

Any and all rights (including, without limitation, copyright, design patent, use patent and trademark) in and to all designs, concepts, renderings, or graphics (collectively, "Design") represented in this document were created by Moss Inc. and remain the sole and exclusive property of Moss Inc. Use of any such Design by the recipient without required purchase is strictly prohibited. ©2010